

# Numerical Investigation in the Effect of Number of Nozzle Hole on Performance and Emission in Dual Fuel Engine

B. Jafari<sup>\*1</sup>, D.Domiri Ganji<sup>2</sup>

1. Assistant Professor, 2. PhD Student, Babol University of Technology, Mechanical Engineering Department, Babol, Iran

\*bahramjafari@gmail.com

## Abstract

Air pollution is one of the major issues about the diesel engines in today's world. It is a special concern in those areas that have difficulty meeting health-based outdoor air quality standards. Natural gas has low emission and resource abundance and also conventional compression ignition engine can be easily converted to a dual fuel mode to use natural gas as main fuel and diesel as pilot injection. The main object of this work is to investigate the effect of number of injector nozzle hole on the combustion and exhaust emission in a gas engine ignited with diesel fuel. We use one and three-dimensional simulation in parallel way in order to analyze the performance and combustion process of a dual fuel engine. The experimental results have also reported and compared with the simulated data.

**Keywords:** Dual fuel engine, Combustion, Emission, CFD, Numerical simulation, Number of nozzle hole

## 1. Introduction

Today, there are lots of diesel engines in the world which are used in power plants; train sets, marine application and so on, but high emissions are those main problems. Recently, researchers and industrial practitioners work on alternative fuel in order to solve these problems, both in academia and industries.

Natural gas is one of the most important fuels that is available in large quantity with lower emission than diesel. To use natural gas in diesel mode, there is a need to have a high compression ratio (about 40). According to engine design limitation, it is difficult to reach this ratio. Using a diesel fuel as pilot is one of the best ways as well as spark plug, which has been done [1].

There are many works and analysis to develop this kind of engine. So the compression ignition engine of the dual fuel type has been employed in a wide range of applications to utilize various gaseous fuel resources and minimize exhaust gas emissions without excessive increase in cost from that of conventional diesel engines [1]. Theoretical study of the effects of engine parameters on performance and emissions of a pilot ignited natural gas diesel engine

has been investigated by Papagiannakis et al. [2] an existing two-zone phenomenological model has been used to examine the effect of the increase of the pilot fuel quantity accompanied with air inlet temperature, on performance and pollutant emissions of a direct injection, dual fuel, diesel–natural gas engine. The comparison between normal diesel and normal dual fuel operation reveals that the simultaneous use of diesel and natural gas leads to higher values of the brake specific fuel consumption. Also Papagiannakis et al. [3] has investigated emission characteristics of high speed, dual fuel, and compression ignition engine operating in a wide range of natural gas/diesel fuel proportions to reduce pollutant emissions from diesel engines. It was shown that the decrease of the total relative air–fuel ratio, which is caused by the increase of diesel fuel supplementary ratio, results to a lower brake thermal efficiency compared to the one under normal diesel operation, thus revealing the deterioration of the engine efficiency under diesel–natural gas dual fuel operating mode.

Natural gas sources are spread throughout the world, which reduces the risk of an energy crisis. Therefore, nowadays, there is an ever-increasing market demand for both new dual-fuel engine designs and for the conversion of existing single fuel direct injection diesel engines to satisfy environmental and

commercial constraints. Numerical simulations study on a pilot ignited natural gas direct injection in diesel engines has been done by Li et al. [4]. The results showed that altering the interlace angle changes the contact areas between the pilot diesel sprays and the natural gas jets; this affects the heat release rate. Statistical analysis was done to evaluate the expected value and variance of "closeness" between diesel sprays and natural gas jets for different injector tip configurations. Uyehara [5] discussed how to control dual fuel engine emissions by studying the combustion of both the diesel and dual fuel engines. Carlucci et.al [6] had been converted a single-cylinder diesel engine into a dual-fuel. The engine had been tested on a wide range of operating conditions spanning different values of engine load and speed. During tests, the engine was operated at two different conditions and, for each of them, methane and diesel fuel injection pressure, together with pilot fuel amount, was varied. It was observed that an analysis of the rate of heat release is not sufficient to explain the effect of each of the injection parameters on the pollutant emissions. In the case of NOx, it was found that the penetration of the jet holds the same importance as the quantity of pilot fuel injected. The more the jet penetrates into the combustion chamber, the more its combustion had been spread into the same chamber, and then the local temperatures had been closer in value to the bulk temperature. Similar conclusions could be drawn for the CO and HC emission levels. Since this kind of engine are new, then there needs to a lot of study and survey to solve its problem and develop it.

In these years, many researchers are developing diesel and dual fuel engine by some know and new ways. In direct injection engines, one of the recommended ways is using a suitable injector for diesel injection.

In this field, the effect of nozzle hole layout on diesel engine performance has been investigated in many researches [7,8]. Khatamnezhad et al. [8] used a nozzle with and without rounding-off hole and found that cavitation level will be decreased significantly with rounding off nozzles. The results show that the sharper nozzle inlet leads to lower spray tip penetration length, larger spray angle and smaller droplet sizes due to stronger cavitation phenomena in the nozzle hole. Semin and Ismail [9] have investigated the effect of injector nozzle holes on diesel engine performance. When they had examined all of injector nozzle, they found that the nozzle with seven holes has the best burning result for the burn fuel in different engine at different speed. Lee et al. [10] explored the behavior of the formation of spray mixtures, combustion, and emissions as a function of

the number of injector hole changes in their study. They propose an optimal number of holes for superior emissions and engine performance in diesel engine applications. The results show that increasing the number of holes significantly influences evaporation, atomization, and combustion. However, when the number of holes exceeds a certain threshold, there is an adverse effect on combustion and emissions due to a lack of the air entrainment required for the achievement of a stoichiometric mixture. The effects of the combined use of exhaust gas recirculation and multi-hole injector with pilot injection on combustion and emissions were investigated on a small direct injection diesel engine equipped with a common-rail injection system by Lee et al. [11]. Tests were performed at fixed engine speed (800 rpm) under idling condition with different EGR ratios and two different nozzle hole numbers (5, 14 holes). The results showed that significant improvements in power output and the simultaneous reduction of NOx and PM could be achieved when pilot injection was applied with 14-hole injector and EGR. Also there is some investigation in this field for gasoline engine. A correlation study on fuel spray pattern recognition of multi-hole injectors for gasoline direct injection (GDI) engines is done by Das et.al [12].

But there is a few studies with injector hole number affection in the dual fuel engine. For this reason and with this background, the investigation of injector nozzle holes for dual fuel engine seems to be very important to optimize emission and performance.

The main target of this contribution is to improve a new heavy duty local produced 12 cylinder diesel engine, called D87, in dual fuel mode of operation (Diesel and gas) by the use of different injectors via CFD simulation. The experimental work done in this paper was conducted on diesel mode and dual fuel mode of operation (20% diesel-80% gas) with 0% EGR in the constant speed (1500 rpm) and full load condition. The experimental results have also reported and compared with the simulated data. We use one and three-dimensional simulation in parallel way in order to analyze the performance and combustion process of a dual fuel engine. In order to investigation of the effect of different injectors on combustion process, we use different nozzle layouts with 6, 7 and 8 holes for pilot diesel injection.

## 2. Experimental Setup

The engine used in the present research was a 12 cylinders, four-stroke, and direct-injection diesel engine with the specifications given in Table 1. The base engine is a DI diesel engine. In order to operate at dual fuel mode, compression ratio was decreased

from 15:1 to 11.5:1 and gas fuel port was added to the base engine.

Fig. 1 shows a schematic of the engine setup in test cell. The engine was coupled to a water brake and the experiments were carried out at 1500 rpm while maintaining a power of full load condition. Crank angle resolved in-cylinder pressure was measured

using a piezoelectric transducer. The primary engine fuel, natural gas, (20% diesel-80% gas) was a mixture of 90.3 percent methane, 4.3 percent ethane, and less than 6 percent nitrogen and carbon dioxide. The natural gas was injected into the air manifold. Fig. 2 shows D87 dual fuel engine in test cell.

Table 1. D87 Engine

Engine type	Diesel Mode	Dual Fuel Mode
Engine speed	1500 rpm	1500 rpm
Bore × stroke	150×180 mm	150×180 mm
Power	1000 kW	850 kW
Compression ratio	15:1	11.5:1
Injector type	Common-rail	Common-rail
Number of nozzle holes	8	8

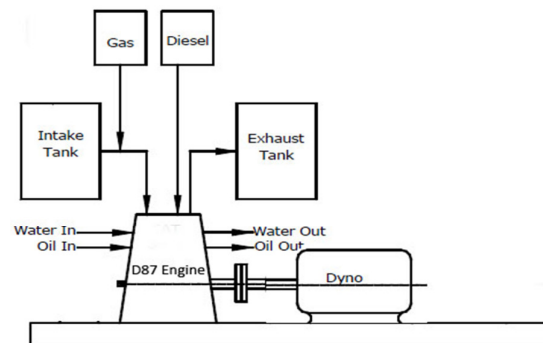

Fig1. Schematic of the engine setup in test cell

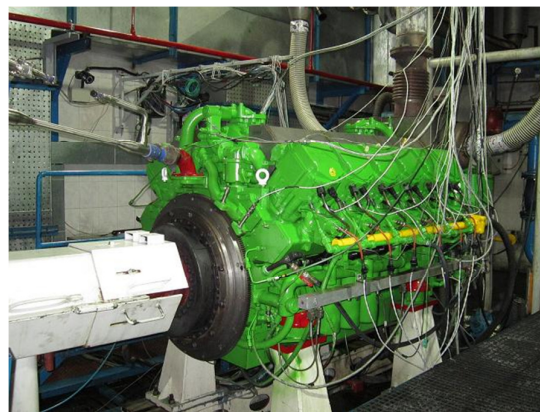

Fig2. D87 dual fuel engine in test cell

### 3. Numerical Model

Diesel engine combustion modeling is a complicated task due to the fact that many competing processes are occurring simultaneously. These include fuel injection, spray break-up, evaporation, auto-ignition, combustion, turbulence generation and dissipation, mixing and heat transfer.

CFD simulation solves the compressible, turbulent, three-dimensional transient conservation equations for reacting multi-component gas mixtures with the flow dynamics of an evaporating liquid spray. The turbulent flows within the combustion chamber are simulated using the k-ε turbulence model, modified for variable-density engine flows.

#### 3.1 Spray Model

The spray module is based on a statistical method referred to as the discrete droplet method. This operates by solving ordinary differential equations for the trajectory, momentum, heat and mass transfer of single droplets, each being a member of a group of identical non-interacting droplets termed a parcel. Thus one member of the group represents the behavior of the complete parcel.

The wave model was selected to represent spray breakup [13]. In this model the growth of an initial perturbation on a liquid surface is linked to its wavelength and to other physical and dynamic parameters of the injected fuel and the domain fluid.

$$\frac{dr}{dt} = \frac{(r - r_{stable})}{\tau_a} \quad (1)$$

Where  $\tau_a$  is the break-up time of the model, which can be calculated as:

$$\tau_a = \frac{3.726 \cdot C_2 \cdot r}{\Lambda \cdot \Omega} \quad (2)$$

The constant  $C_2$  corrects the characteristic breakup time and varies from one injector to another.

$r_{stable}$  is the radius of the product droplet, which is proportional to the wavelength  $\Lambda$  of the fastest growing wave on the liquid surface:

$$r_{stable} = C_1 \cdot \Lambda \quad (3)$$

The wavelength  $\Lambda$  and wave growth rate  $\Omega$  depend on the local flow properties.

The Dukowicz model [14] was applied for treating the heat-up and evaporation of the droplets. This model assumes a uniform droplet temperature. The changing rate of droplet temperature is determined by the heat balance, which states the convected heat from the gas to the droplet either heats up the droplet or supplied heat for vaporization.

#### 3.2 Combustion Model

The extended coherent flame model has been used in order to describe combustion in diesel and gasoline engines. The CFM is applicable to both premixed and non-premixed conditions on the basis of a laminar flamelet concept, whose velocity  $SL$  and thickness  $\delta L$  are mean values, integrated along the flame front, only dependent on the pressure, the temperature and the richness in fresh gases. Such a model is attractive since a decoupled treatment of chemistry and turbulence is considered. All flamelet models assume that reaction takes place within relatively thin layers that separate the fresh unburned gas from the fully burnt gas. Using this assumption, the mean turbulent reaction rate is computed as the product of the flame surface density  $\Sigma$  and the laminar burning velocity  $SL$  via:

$$\rho \cdot \dot{r}_{fu} = -\omega_l \cdot \Sigma \quad (4)$$

$\omega_l$  is the mean laminar fuel consumption rate per unit surface along the flame front. For lean combustion:

$$\omega_l = \rho_{fu,fr} \cdot S_l \quad (5)$$

$$\rho_{fu,fr} = \rho_{fr} \cdot y_{fu,fr} \quad (6)$$

In this equation  $\rho_{fu,fr}$  is the partial fuel density of the fresh gas,  $\rho_{fr}$  the density of the fresh gas and  $y_{fu,fr}$  is the fuel mass fraction in the fresh gas. The diesel ignited gas engine model combines homogeneous premixed gas combustion with Diesel ignition. The auto-ignition model is chosen automatically. Auto-ignition is calculated in regions which are richer than the homogeneous mixture.

#### 3.3. Emission Models

The extended Zeldovich mechanism [15] has been implemented to describe nitric oxide (NOx) formation. The classical extended Zeldovich scheme as follows by:

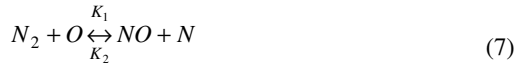

NOx formation has been found to be very sensitive to small changes in the computed in-cylinder gas temperature field. The relation between NO production and in-cylinder temperature is as follow:

$$\frac{d[NO]}{dt} = \frac{6 \times 10^{16}}{T^{1/2}} \exp\left(\frac{-69090}{T}\right) [O_2]^{1/2} [N_2] \tag{10}$$

**4. Model Description**

The commercial CFD softwares AVL-FIRE and GT power were used to perform the numerical simulation of engine performance, combustion and emission formation in D87 engine.

Combustion characteristics and its influence on flow field and emission formation was investigated in three-dimensional CFD model in Fire code. A three-dimensional combustion chamber model has been shown in Fig. 3. As there are eight holes in the used nozzle, then the constructed model contains one hole and 45 degree. This takes advantage of the symmetry of the chamber geometric setup, which significantly reduces computational runtime. At TDC, the whole mesh number is 19385 cells. This mesh size will be able to provide good spatial resolution for the distribution of most variables in the combustion chamber. Calculations are carried out on the closed system from IVC at -150°CA ATDC to EVO at 120°CA ATDC.

The generated model in Fire code is a close cycle in compression and expansion stroke of engine. Therefore, EGR and turbocharging affection cannot be simulated on the initial condition of engine such as boost pressure and initial temperature. Also, engine performance parameters such as IMEP, BSFC and etc. cannot be achieved in closed cycle simulation

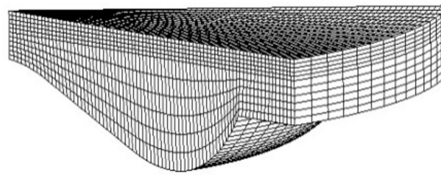

Fig3. Computational mesh at 20 degree CA BTDC

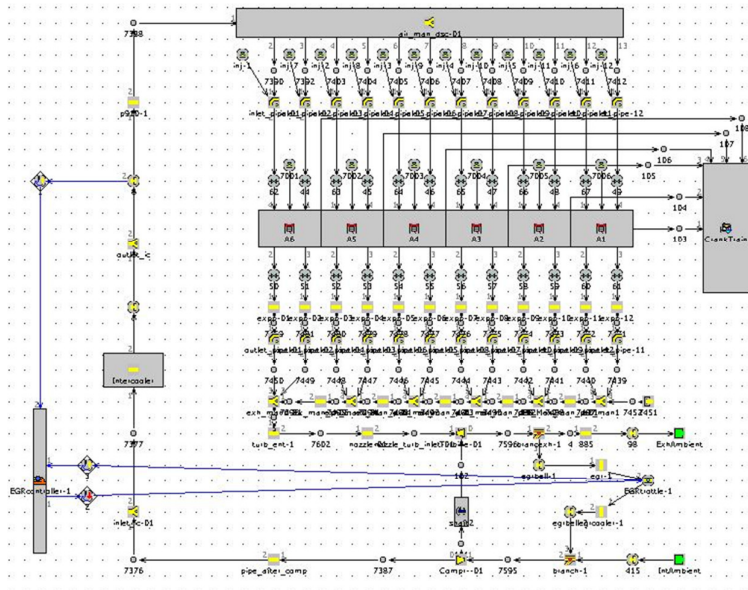

Fig4. Computational model in GT Power software

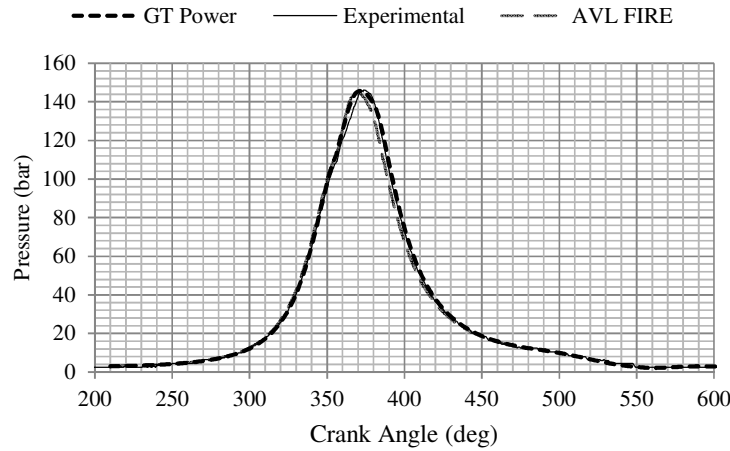

Fig5. Comparison between experimental with 1D and 3D simulation data in diesel engine

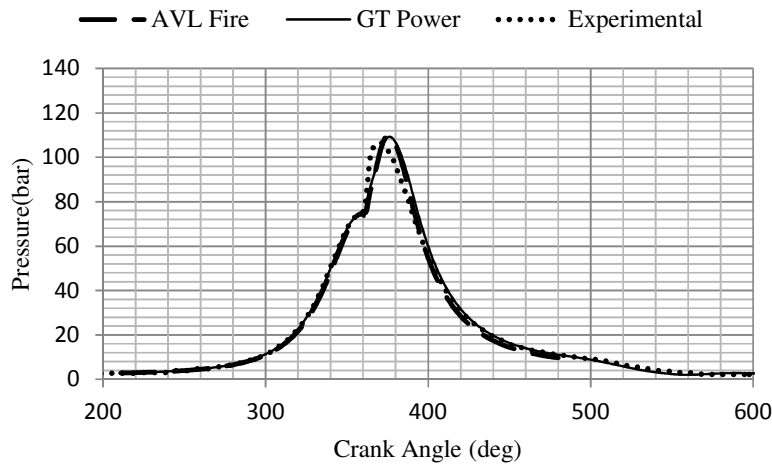

Fig6. Comparison between experimental with 1D and 3D simulation data in dual fuel engine

GT power software is a one dimensional CFD model that can simulate the four stroke of engine operation. Therefore, GT Power software has been used in this paper to determine the initial condition in different cases as well as engine performance. In order to simulate the combustion process in cylinder in one dimensional CFD model, the measured heat release rate in three-dimensional simulation has been imported as a burn rate profile. So, the heat release

rate was imported to the GT and the constructed model according to Fig. 4 solved it. Results of one dimensional including inlet pressure, inlet temperature and equivalence ratio was imported to the three-dimensional model and re-run with new condition. This procedure had continued to reach a small residual between two simulations. Therefore, combustion process, emission formation and engine performance was investigated in different conditions

in parallel simulation of one and three-dimensional CFD simulation.

## 5. Results and Discussion

In this research, parametric study has been conducted to investigate the effect of different nozzle holes layouts on combustion and emission in D87 dual fuel engine in parallel simulation with Fire and GT power code.

Before using the CFD model to examine the effect of different nozzle layout on combustion process and emissions, it is necessary to validate its predictive ability. For this reason, we have used experimental data for the target engine that mentioned above with FIRE and GT Power.

Fig. 5 indicates the comparison of simulated and experimental in-cylinder pressures against the crank angle for the D87 diesel engine with SOI at 12 degree CA BTDC in full engine load condition. The good agreement of predicted in-cylinder pressure with the experimental data can be observed. It is due to time step and computational grid independency of the results. Also, the simulated in-cylinder pressure in compared to experimental value has been illustrated in Fig. 6 for dual fuel operation mode (20% diesel-80% gas) in full engine load condition. There is a good agreement between the results. Therefore, the CFD and combustion simulation model performed in this study are able to represent the real combustion process inside engine and have the capability to be implemented for further calculation.

In this research, to investigate the effect of nozzle holes, three kinds of injector have been chosen. These injectors have 6, 7 and 8 holes and their specification is shown in Table 2

As there are 6, 7 and 8 holes in the used nozzles, the constructed model contains one hole and 60, 51 and 45 degree with the whole mesh number 20160, 17280 and 15360 cells at TDC, respectively. This takes advantage of the symmetry of the chamber geometric setup, which significantly reduces computational runtime. This mesh size will be able to provide good spatial resolution for the distribution of most variables in the combustion chamber.

This simulation is analyzing all cases in a same situation and condition, and then the total injected mass should be equal. So, the final input data for every one of injector is according to Table 3:

With fewer nozzle holes in the injector and its bigger diameter, the total injected mass for one hole will increase. As it is shown in Table 3, although, the hole diameter for 6 holes injector is bigger but its total diameter is less than 7 holes injector. This causes an increase in the injected droplet diameter.

With bigger droplet, when the pressure is the same, particle velocity will be decreased. With following equation, fuel jet velocity can simply calculated in the outlet of nozzle hole:

$$\dot{m} = \rho AV \quad (11)$$

If  $\dot{m}$ ,  $\rho$  and A are constant, the amount of injected fuel velocity is shown in Table 4:

**Table 2.** Used injectors specification

Injector specification	1	2	3
Number of holes	6	7	8
Diameter (mm)	0.29	0.27	0.25
Area (mm <sup>2</sup> )	0.066	0.05722	0.049
Total area (mm <sup>2</sup> )	0.396111	0.4006	0.3925

**Table 3.** Differences between nozzles in terms of functional

specification	6 holes injector	7 holes injector	8 holes injector
Injection during (deg)	6.66	6.66	6.66
Total mass (mg)	54	54	54
Injection mass per hole (mg)	9	7.71	6.75
Average injection rate in each hole (mg/deg)	1.385	1.177	1.037

**Table 4.** Droplet velocity in different injectors

injector	6 holes	7 holes	8 holes
Velocity(m/s)	224.8	220.4	299.5

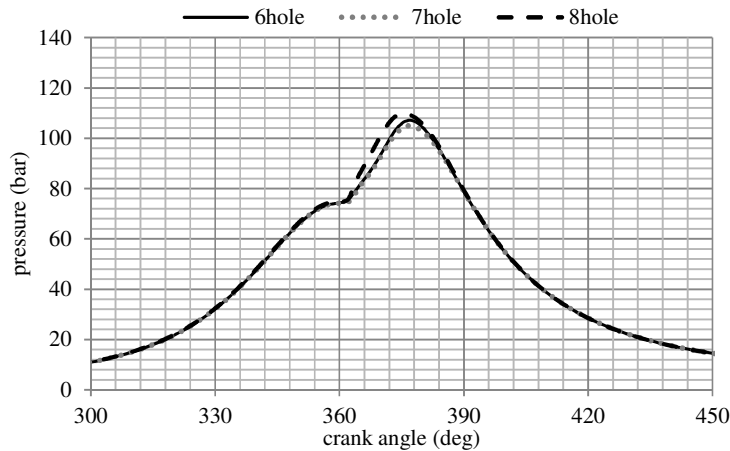
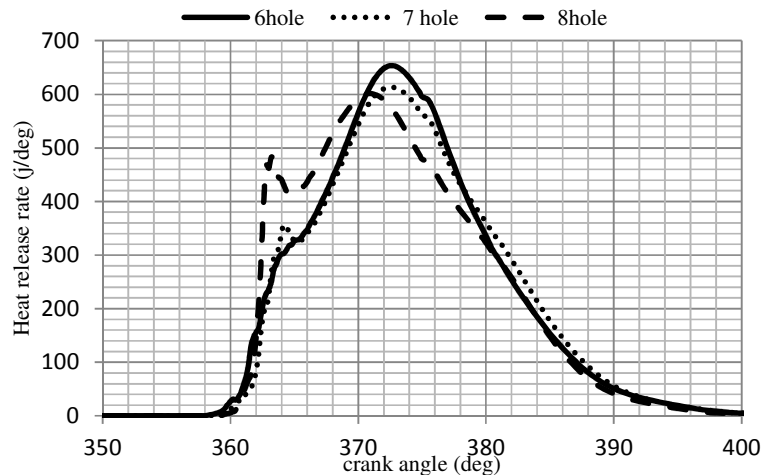
**Fig7.**Pressure alteration with different injector**Fig8.**Heat release rate in different cases

The effect of injector nozzle holes on cylinder pressure has been shown in Fig. 7. As it is shown, the maximum pressure will be increase in 8 holes nozzle. This increment is because of higher pilot diesel injection velocity for 8 holes injector rather than 6 and 7 holes. When injection velocity is increased,

droplets penetrate slightly further into the combustion chamber because of high momentum liquid droplets and higher injection velocity. This leads to the increase of air entrainment into the fuel spray because of the longer spray path before impinging piston bowl. Also, higher injection velocity results in smaller



diesel fuel droplet size at ignition delay. This is due to the aerodynamic forces induced by the relative velocity between liquid fuel ligaments or bigger droplets and the surrounding gas intensify break-up of the droplet and distributions of droplets are reduced at ignition delay. This leads to better mixture between diesel fuel with air. Therefore, premixed combustion will be improved in eight hole nozzle.

In order to further explanation, Fig. 8 shows the rate of heat release with different used nozzles. In the present study, the ignition delay is defined with two parts that contains diesel ignition and gas ignition in the heat release rate curve. The diesel fuel with eight hole nozzle ignited with a faster rate and then causes a shorter duration for gas ignition. This is because of the diesel break up has been increased in eight hole nozzle due to higher injection velocity. Therefore, air-fuel mixing will enhance in ignition delay. At the other hand, six hole nozzle has a higher rate than seven holes in diffusion combustion. This is due to slower air-fuel mixing in 7 holes injector.

The in-cylinder temperature has been shown in Fig. 8. It can be seen that a little increase in the maximum temperature in the combustion chamber. This increase is very slight and same as pressure causes with eight hole nozzle.

The effect of different injector holes on the overall NOx and CO emission at EVO can be seen in Fig. 10 and Fig. 11.

Both oxygen availability (low local equivalence ratio) and high temperature conditions satisfied NOx formation increases, but high temperature flame leads to a more NOx formation than the oxygen concentration. The areas that the equivalence ratio is close to 1 and the higher temperature more than 2000

K is the NOx formation area, which agrees well with data in literature.

Also, CO oxidation is dependent to OH radical strongly and it has close relation with in cylinder temperature. This means that when there is no obviously change in the combustion temperature (in the expansion stroke) there will not be a clear difference in the CO mass fraction. Also for NO mass fraction, there is the same argument. NOx is formed at high temperatures due to the high activation energy of the  $O + N_2 \rightarrow NO + N$  reaction in the Zeldovich mechanism. In order to further explain for in-cylinder flow field, a general comparison is presented for our interest crank angles at different injector nozzles. Fig. 12 shows the contour plots of equivalence ratio when combustion process has been started in a cross-section taken diagonally across the bowl and splitting it in half at 350 CA, 360 CA, 370 CA and 380 CA, respectively. Higher mixture fraction inhabit in the periphery of the leading edge of the spray tip owing to the existing of smaller droplets in this region. As it can be seen in 370 CA and 380 CA, there is a more homogenous mixing of air and fuel in eight hole nozzle and there are large fuel rich regions (high equivalence ratio) near wall surface.

In Fig. 13 is shown the chamber temperature in different crank angles as three-dimensional contours. The results indicate in eight hole nozzle, better air-fuel mixing is available at ignition delay which leads to higher peak value of premixed combustion and combustion temperature in 370 CA in piston bowl. However, the distribution of in-cylinder temperature has a little increase in 8 holes nozzle in comparison to other nozzle layout.

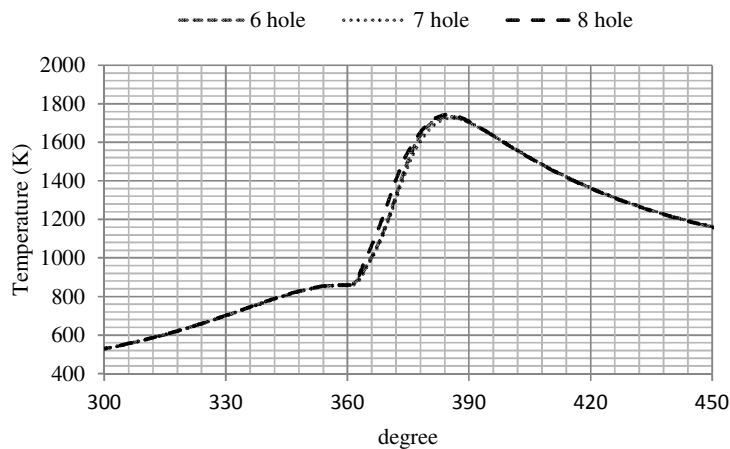

Fig9. Temperature alteration with different injector

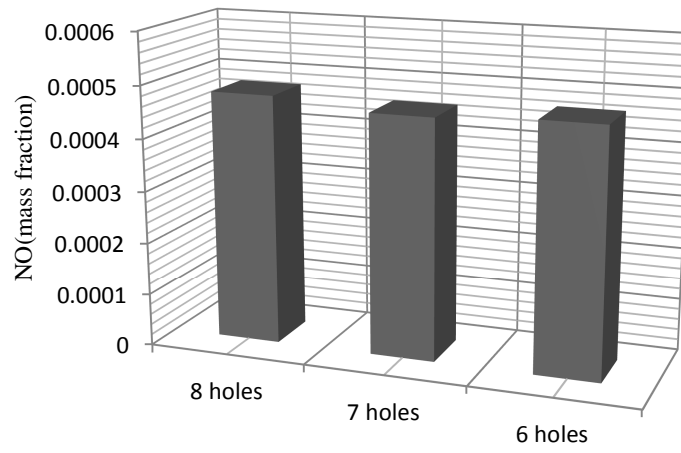

Fig10. CO mass fraction with different nozzle holes

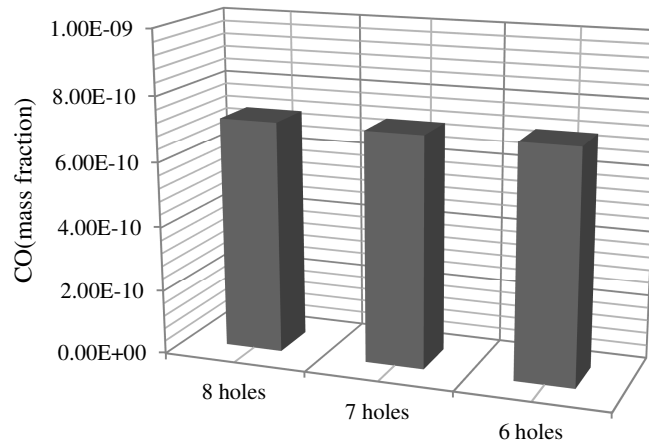

Fig11. NO mass fraction with different nozzle holes

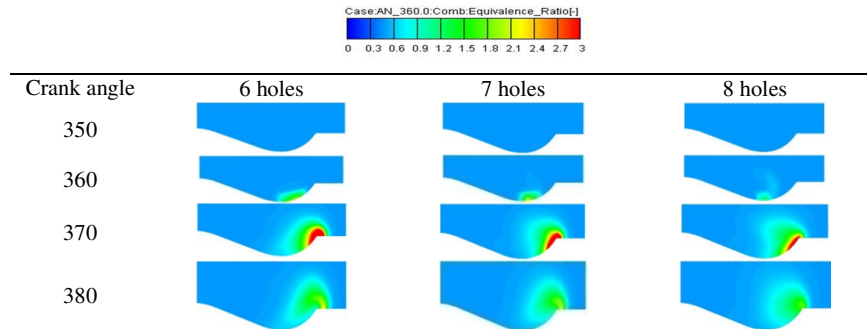

Fig12. 2D contour of equivalence ratio in different crank angle for injectors

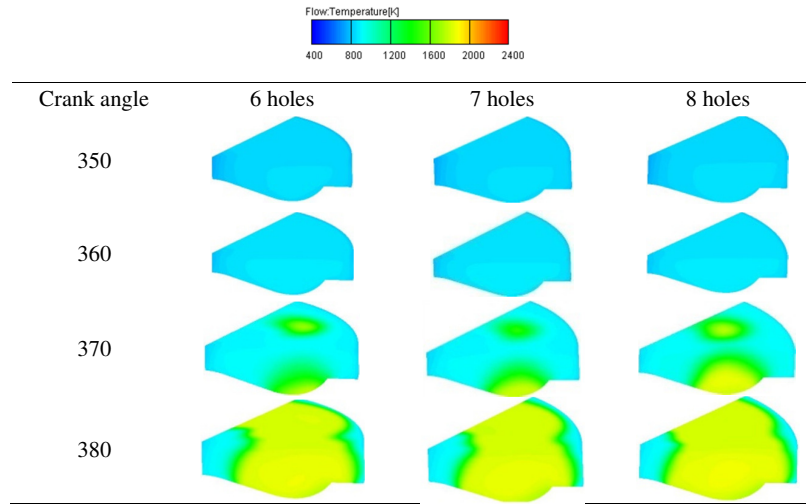

Fig13. 3D contour for temperature with different injectors

Table 5. Engine performance characteristic in different cases

Performance characteristic	injector		
	6 holes	7 holes	8 holes
power (HP)	1132	1130	1140
Power (kW)	844.6	842.6	850
Brake Torque (N.m)	5376	5364	5412
BMEP (bar)	17.7	17.66	17.8
BSFC (g/kw.h)	192.3	192.8	191.12

In order to obtain engine performance characteristic, some parameter such as power and BSFC is calculated. These parameters are calculated by:

$$w = \int p dv \quad (12)$$

where  $w$  = work,  $p$  = pressure and  $v$  = volume.

The swept volume ( $dv$ ) for all configurations is the same. Therefore, the existed different is for in cylinder pressure. Then it is simple to calculate brake power in 1500 rpm:

$$\dot{w} = \frac{w \cdot N}{n} \quad (13)$$

for 4 stroke engine,  $n$  is 2. Brake specific fuel consumption is:

$$BSFC = \frac{\dot{m}_{fuel}}{\dot{W}} \quad (14)$$

Table 5 shows engine performance characteristic in different cases. These results were getting based on to the results obtained with 1-D performance simulations. Output power increases with 8 holes injector. In this regard the brake torque increases with 8 and 6 holes respectively. These results shows that if we use an injector with more holes but low injection surface, it causes injection to be faster and then can reduce BSFC as well as other advantages. The fuel consumption of the eight hole nozzle is quite different other hole nozzle case.

### Conclusion

Environmental, economics, saving energy and using waste alternative fuel are worldwide important issues. Dual fuel (gas and diesel) engine has a good position for power plant and transportation system. In this research, different injectors with difference in the nozzle holes have been investigated in a dual fuel engine. By parallel simulation of the three-dimensional model in the FIRE code with one dimensional model in GT Power software, the ignition and combustion has been modeled. The effects of the number of nozzle holes on engine performance were investigated on the 12 cylinders engine. The effect of the number of nozzle holes on CO and NO<sub>x</sub> mass fraction is observed, too. Higher diesel injection velocity in eight hole nozzle increases output power as well as brake torque and BSFC in a dual fuel engine due to better air-fuel mixing and higher in-cylinder pressure. Besides, the results show that the number of nuzzles has a little effect on NO<sub>x</sub> and CO emission formation in dual fuel engine.

### References

- [1]. G. A. Karim and Z. Liu. "A Predictive Model for Knock in Dual Fuel Engines". Transactions of SAE, 1992, SAE Paper No.921550.
- [2]. R.G. Papagiannakis, P.N. Kotsiopoulos, T.C. Zannis, E.A. Yfantis, D.T. Hountalas, C.D. Rakopoulos. "Theoretical study of the effects of engine parameters on performance and emissions of a pilot ignited natural gas diesel engine". Energy xxx (2009) 1–10.
- [3]. R.G. Papagiannakis, C.D. Rakopoulos, D.T. Hountalas, D.C. Rakopoulos. "Emission characteristics of high speed, dual fuel, compression ignition engine operating in a wide range of natural gas/diesel fuel proportions". Fuel xxx (2009) xxx–xxx.
- [4]. G.Li, P.Ouellette, S.Dumitrescu, P.G.Hill,. 1999. "Optimization Study of Pilot-Ignited Natural Gas Direct-Injection in Diesel Engines". SAE, paper NO 3556
- [5]. O. A .Uyehara, "Prechamber for Lean Burn for Low NO<sub>x</sub>," SAE 950612, 1995.
- [6]. A.P. Carlucci, A. de Risi, D. Laforgia, F. Naccarato. "Experimental investigation and combustion analysis of a direct injection dual-fuel diesel–natural gas engine". Energy 33 (2008) 256–263.
- [7]. T.N. Tuan, H. Okada, T. Tsukamoto, K. Ohe, K. Iwasawa,. "Effect of Rounding-off Nozzle Hole Inlet on Fuel Injection and Combustion Characteristics under High-Temperature and High-Pressure". Translated from Journal of the JIME Vol.42, No.2
- [8]. H. Khatamnezhad, Sh. Khalilarya, S. Jafarmadar, A. Nemati and B. Jafari "The Influence of Cavitation Phenomenon in a Diesel Injector on the Spray Characteristics and Combustion Process of a Di Diesel Engine". Australian Journal of Basic and Applied Sciences, 5(6): 538-555, 2011.
- [9]. Semin, A.R. Ismail,. "Effect of injector nozzle holes on diesel engine performance". Fuel Injection.
- [10]. B. H. Lee, J. H. Song, Y. J. Chang, C. H. Jeon,. "Effect of the number of fuel injector holes on characteristics of combustion and emissions in a diesel engine". International Journal of Automotive Technology, December 2010, Volume 11, Issue 6, pp 783-791.
- [11]. S. Das, S.I.Chang and J. Kirwan. "Spray Pattern Recognition for Multi-Hole Gasoline Direct Injectors Using CFD Modeling". SAE, 2009-01-1488.
- [12]. S. Lee, S. Kook, W. Choi, C. Bae and J. Kim. "The Combined Effect of Multi-hole Injector with Pilot Injection and EGR in a HSDI Diesel Engine".
- [13]. J.C. Beale, and R.D. Reitz, "Modeling Spray Atomization with the Kelvin-Helmholtz/Rayleigh-Taylor Hybrid Model." Atomization and Sprays, NO. 9, pp. 623-650, 1999.
- [14]. A.B. Liu, and Reitz, R.D. "Modeling the Effects of Drop Drag and Break-up on Fuel Sprays", SAE 930072.
- [15]. J.K. Dukowicz, "Quasi-Steady Droplet Phase Change In the Presence of Convection." Informal Report Los Alamos Scientific Laboratory, LA7997-MS, 1979.